

SIDE VIEW NEON FLEX / 04×08MM

FEATEURES:

- Low power consumption and high light efficiency
- Vivid and pure light without light spots
- DC 24V for higher safety and durability
- anti-yellowing and anti-UV silicone coating
- IP67 waterproof for outdoor use
- Cuttable to satisfy various requirements on strip length
- Flexible enough for different lighting projects (bend diameter:>30mm)
- 50,000+ hour long lifespan

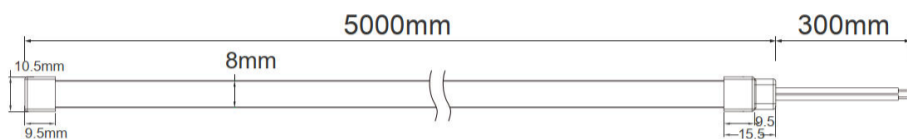

Item Code	Input Voltage	Watt/m	CCT/K	CRI	Lm/m	Lm/ft	Lm/w	IP Rate	Cutting Length (Min.)	Max. Run Length
HL4N-24V-2216-240L-2100K	24V	6	2100K ⁺²⁰⁰ ₋₁₀₀	>90	199	60	33	IP67	25mm	5m
HL4N-24V-2216-240L-2400K	24V	6	2400K ⁺²⁰⁰ ₋₁₀₀	>90	212	64	35	IP67	25mm	5m
HL4N-24V-2216-240L-2700K	24V	6	2700K ⁺²⁰⁰ ₋₁₀₀	>90	219	67	37	IP67	25mm	5m
HL4N-24V-2216-240L-3000K	24V	6	3000K ⁺³⁰⁰ ₋₂₀₀	>90	253	77	42	IP67	25mm	5m
HL4N-24V-2216-240L-4000K	24V	6	4000K ⁺³⁰⁰ ₋₂₀₀	>90	223	68	37	IP67	25mm	5m
HL4N-24V-2216-240L-5000K	24V	6	5000K ⁺⁴⁰⁰ ₋₃₀₀	>90	214	65	35	IP67	25mm	5m
HL4N-24V-2216-240L-5500K	24V	6	5500K ⁺⁴⁰⁰ ₋₃₀₀	>90	221	67	36	IP67	25mm	5m

OPTICAL PARAMETER

LED Type: SMD2216
 Color Rendering Index: >90
 CCT Range: 2100K-55000K
 Beam Angle: 120°
 Light Efficiency: 33~42Lm/w
 Lumen Output/meter: 199~253Lm/m(60~77Lm/ft)

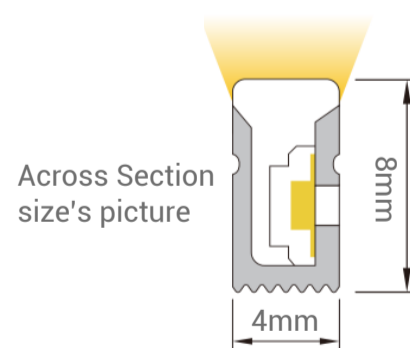

ELECTRIC PARAMETER

Input Current/m: 0.25(Max)A/m
 Input Voltage: DC24V
 Power/M: 6(Max)W/m
 Static Electricity: 1000V (ESD)
 Size of Section: 25mm
 LEDs/Meter: 240LEDs/m
 LEDs of Section: 6 LEDs

